A large, stylized letter 'M' is the central focus of the image. It is rendered in a light gray color against a solid black background. The 'M' is composed of thick, solid lines. The right-hand vertical stem of the 'M' is wider than the left-hand one. The text 'user guide' is written in a white, lowercase, sans-serif font, following the diagonal slope of the right-hand stem of the 'M'.

user guide

Meridian 588 Compact Disc Player

**Meridian 588
Compact Disc Player
User Guide**

Sales and service in the UK

Meridian Audio Ltd
Stonehill
Stukeley Meadows
Cambs
PE29 6EX
England

Tel (01480) 52144
Fax (01480) 459934

World Wide Web
<http://www.meridian-audio.com>

Sales and service in the USA

Meridian America Inc
3800 Camp Creek Parkway
Building 2400
Suite 122
Atlanta
GA 30331

Tel (404) 344 7111
Fax (404) 346 7111

Designed and manufactured in the UK by

Meridian Audio Ltd
Stonehill
Stukeley Meadows
Cambs
PE29 6EX
England

Copyright © 1993–2001
Meridian Audio Ltd

Part no: 588/1

This guide was produced by
Human-Computer Interface Ltd,
<http://www.interface.co.uk>

Contents

Introduction 1

Introduces the 588 Compact Disc Player, and provides an overview of the other products available in the Meridian 500 Series.

The Meridian 500 Series	2
Sample configurations	3
Specification and accessories	5

Using the compact disc player 7

Provides step-by-step instructions on how to operate the compact disc player, using either the front panel or the Meridian System Remote.

Front panel	8
Switching on and off	9
Playing a disc	10
Stopping and pausing play	11
Repeating play	12
Programming a selection	13
Disc information and scanning	15
Changing the absolute phase	16

Setting up the compact disc player 17

Describes how to unpack and install the compact disc player.

Unpacking	18
Positioning the compact disc player	19
Connecting the compact disc player	20
Connecting audio	23

Configuring the compact disc player 25

Explains how to configure the compact disc player to suit the other equipment in your system.

Choosing standard settings	26
Specifying information about your system	27

Troubleshooting 29

Provides suggested solutions to typical problems.

Troubleshooting	30
Maintenance	33
Service and guarantee	34
Index	35

Introduction

The 588 Compact Disc Player combines Meridian's extensive experience of producing audiophile compact disc players with their experience in applying state-of-the-art digital signal processing techniques to audio equipment, resulting in an outstanding compact disc player that takes full advantage of the capabilities of compact disc.

The 588 uses a precision CD-ROM drive, with the data read asynchronously and then triple buffered to isolate output timing from the mechanics of the drive. The audio is also dejittered using very precise master oscillators to give a clear, open, authoritative sound.

For instructions on setting up the unit turn to *Setting up the compact disc player*, page 17. Once the compact disc player has been set up refer to the next chapter, *Using the compact disc player*, for information about playing discs.

The Meridian 500 Series

The Meridian 500 Series is a unique system of digital, analogue, and video components designed to meet the demand for absolute quality, ease of use, and lasting value.

The flexibility of the Meridian 500 Series is such that you can assemble a system as simple or as complex as you need, perfectly suited to your musical and environmental requirements, and which can be added to or changed at a later date should your requirements change.

Each Meridian 500 Series component is housed in a matching slim line case. Front panel controls provide access to the most important functions, and the full range of functions is available from the Meridian System Remote using a simple and intuitive control interface.

500 Series communications

The Meridian 500 Series includes a sophisticated communications link, to ensure that any configuration of units will work together as a fully integrated system.

The 500 Series communications system allows you to control any combination of units using a single remote, and ensures that your commands from the remote are interpreted unambiguously. The communications system also allows you to extend your hi-fi system into two or three rooms, with the ability to control the sources in one room from the controller in another room.

Professional features

The 500 Series also includes features for professional users, including RS232 computer control and balanced connections.

The following pages give examples of three suggested configurations incorporating the 588 Compact Disc Player, to illustrate the flexibility of the Meridian 500 Series.

Sample configurations

502 Analogue controller

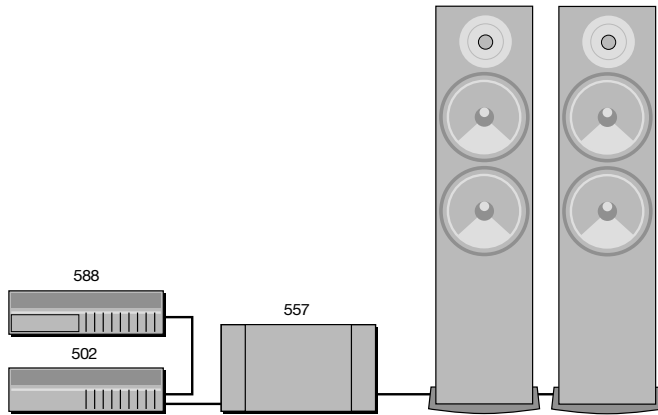

The 588 Compact Disc Player is ideally suited for use with the Meridian 557 Stereo Power Amplifier and analogue loudspeakers, with control over the volume and source selection provided by the 502 Analogue Controller. These units provide balanced inputs and outputs, allowing you to create a completely balanced system.

562 Digital Control Unit

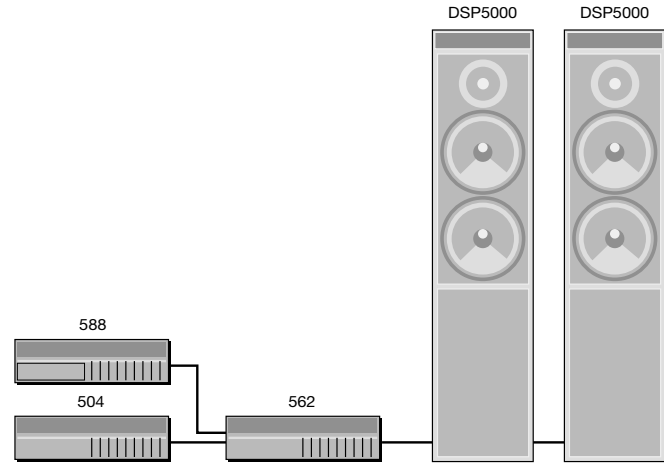

The 588 Compact Disc Player provides a precision digital output, and so is ideal for use with the 562 Digital Control Unit. This can also cater for conventional analogue sources, and provide source selection between up to 12 different analogue or digital sources.

Meridian Digital Music System

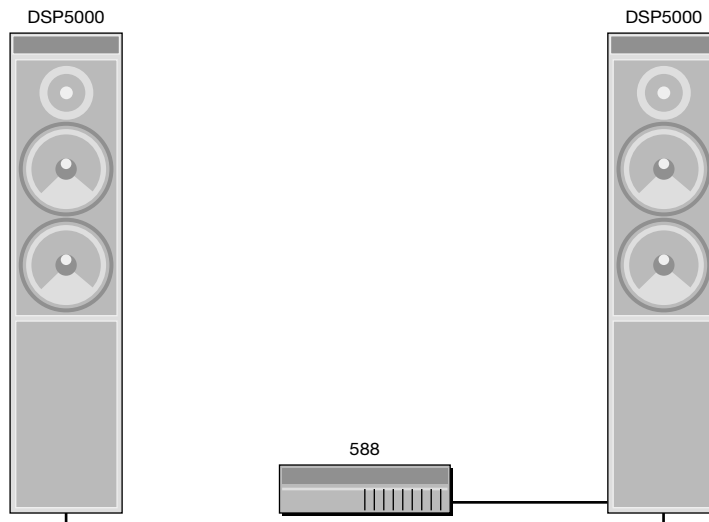

The digital output of the 588 Compact Disc Player can be connected directly to Meridian DSP loudspeakers, as these include DSP volume and tone controls.

The result is an outstanding music system for those who prefer a minimum of separate units and interconnecting cables.

Specification and accessories

Specification

THD	Less than -93dBFS.
Noise	Less than -93dBFS.
Mechanism	Dual-lens pickup with red laser.
Formats	CD Audio (CD-DA) and MP3.
Processing	DSP software provides error correction and on-board decoding for MPEG Audio.
Conversion	24-bit Delta Sigma.
Finish	Black textured enamel and glass.
Dimensions	88mm x 321mm x 332mm (3.46" x 12.64" x 13.07").
Weight	6.4kg (14lbs).
Digital outputs	1 x coax SPDIF/IEC1937. 1 x optical output, TosLink to EIAJ, IEC958 and data compatible.

Analogue outputs

1 x pair balanced outputs XLR sockets, 1=ground, 2=positive phase output, 3=negative phase output.
1 x stereo analogue direct-coupled design featuring 192kHz 24-bit conversion. All audio outputs use FIFO and relocking to give extremely low jitter.

Communications

Two 5 pin 240° DIN sockets. Full RS232 control and status for custom integration or automation.

Power

Universal supply 100-240V, 50-60Hz, 25W.

Available accessories

The following accessories are available from your dealer:

- Meridian System Remote.
- Power cord Europe.
- Power cord Canada and USA.

The Meridian System Remote provides access to all the facilities provided by the 588 Compact Disc Player, including those available from the front panel controls. In addition, it allows you to control any other 500 Series units in your system.

If you have problems purchasing these items, you can order them direct from Meridian Audio Limited, who can also supply a range of digital cables suitable for connecting the 588 Compact Disc Player to other equipment.

Using the compact disc player

This chapter provides a summary of the functions of the compact disc player in order to identify the controls which you use to operate the unit.

It also describes all aspects of using the compact disc player, beginning with essential instructions such as switching on and loading a disc, to the more advanced functions such as programming.

Unless otherwise specified, each function is available from the front panel or the Meridian System Remote.

Front panel

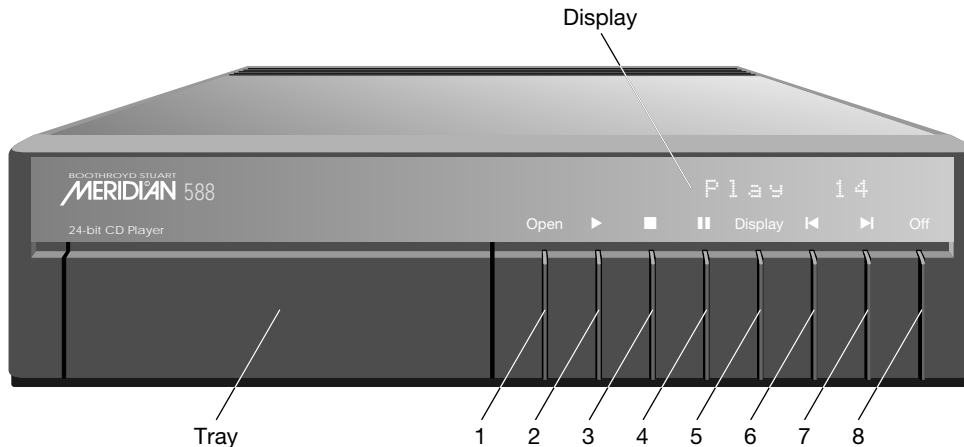

- 1 Open**
Opens and closes the disc tray.
- 2 ► (Play)**
Plays a selected track, or moves to the next track.
- 3 ■ (Stop)**
Stops the disc.
- 4 || (Pause)**
Pauses the disc.
- 5 Display**
Selects the information displayed.
- 6 ◀ (Previous)**
Selects the previous track.
- 7 ▶ (Next)**
Selects the next track.
- 8 Off**
Switches to standby.

Switching on and off

During normal use the compact disc player should be left in the standby state. This uses a negligible amount of electricity, but ensures that the components operate at maximum efficiency from the moment you start playing a disc.

If you are not going to use the compact disc player for a period of several days you should switch the unit completely off, at the back panel, and disconnect it from the AC power supply.

To switch on from standby

- Press **Open**, **■**, or **▶** (front panel), or select a source on the remote.
- Switch on any other equipment connected to the compact disc player which is not part of the Meridian 500 Series.

The display will flash for a few seconds. The compact disc player is then ready for use.

To insert a disc

- Press **Open** (front panel) or **Function ■** (remote) to open the tray.
- Place your disc, label side up, in the tray as shown opposite.

- Press **Open** (front panel), **Function ■** (remote), or **▶** to close the tray.



To switch to standby

- Press **Off**.

The display will show:



If you have other Meridian 500 Series equipment connected to the compact disc player, these units will also switch to standby.

If a disc is currently playing, switching to standby will stop the disc, and the disc can safely be left in the unit.

Playing a disc

The compact disc player allows you to play an entire disc, or start playing from any track. While a disc is playing you can go back to the start of the track or skip to the start of the next track.

If you have programmed a selection, these functions also work with the selection of tracks you have programmed. For information about programming; see *Programming a selection*, page 13.

To play the disc

- Press ► (front panel or remote).

The display will show your selection:



The display will then show the track being played:



To restart the current track

- Press ◀ (front panel or remote).

To move to the next track

- Press ► (front panel or remote).

To play starting from a particular track

- Press ► or ◀ (front panel or remote) to step through the track numbers until the track you want to play is displayed, or type the number of the track (remote only).

For example:



After a short delay the track you have selected will start to play.

If you have other Meridian sources you should ensure that the 588 is the currently selected source.

Stopping and pausing play

You can pause a disc while keeping it spinning, so that you can resume play instantly.

To stop play

- Press ■ (front panel or remote).

The display will show the total number of tracks on the disc.

For example:



To pause play

- Press || (front panel or remote).

The disc will remain spinning and the display will show **Pause**.

For example:



To continue after pausing



- Press || or ► (front panel or remote).

Repeating play

You can set a disc to play repeatedly, so that when the disc (or selection) has played, it will begin again from the beginning. This function is only available from the remote.

To continuously repeat a disc

- Press **Repeat** (remote) to select between the following options:

<i>Display</i>	<i>Description</i>
	Repeat current track.
	Repeat album (MP3 discs only).
	Repeat entire disc.

To repeat between two positions

- Press **A-B** (**Function Repeat** on the remote) at the start of the section you want to repeat.

The display shows:



- Move to the end of the section you want to repeat.

- Press **A-B** again.

The display shows:



The section you have specified will be played repeatedly.

To cancel A-B repeat

- Press **A-B**.

To cancel the repeat function

- Press **Repeat** (remote) again.

Programming a selection

You can programme a selection of tracks and then play only the tracks in your selection.

You can only programme a selection using the remote.

You can programme a selection either by storing the tracks you want to play, or by clearing the tracks you do not want to play. If you programme a selection by storing the tracks you want to hear, you can play the tracks in any order and repeat tracks in the sequence.

You can programme a selection while the disc is playing, in which case the selection will be played after the current track finishes.

Attempting to programme more than 31 tracks will display an error message:

A rectangular display showing the word "Error" in a monospaced font.

To choose a track to programme

- Press **◀** or **▶** to step through the track numbers until the track you want is displayed, or type the number of the track you want.

To programme by storing the tracks you want to play

- Choose the first track you want to play, as described above.

The display will show the track number; for example:

A rectangular display showing the text "Track 14" in a monospaced font.

- Press **Store**.

The display will change to:

A rectangular display showing the text "Store 14" in a monospaced font.

You should store the track within two seconds, or it will begin to play.

The track will be labelled Store.

All the other tracks are initially programmed not to play, and will be labelled Clear.

To programme by clearing the tracks you do not want to play

- Choose one of the tracks you do not want to play, as described above.

The display will show the track number; for example:



- Press **Clear**.

The display will change to:



You should clear the track within two seconds, or it will begin to play.

The track will be labelled **Clear**. All the other tracks are initially programmed to play, and will be labelled **Store**.

To add a track to a selection

- Select the track you want to add, as described above.
- Press **Store**.

The **Clear** label will change to **Store** to indicate that the track is stored.

To remove a track from a selection

- Select the track you want to remove, as described above.
- Press **Clear** (remote only).

The **Store** label will change to **Clear** to indicate that the track has been cleared.

To clear a programme

- Press **■** twice (front panel or remote).

The display will show **C.P.** (Cancel Programme):







A programme is automatically cancelled if you open the disc drawer, or press **Off**.

Disc information and scanning

To change the display

- Press **Display** (front panel or remote).

Each time you press the appropriate key, the display will step between the following display options:

<i>Display</i>	<i>Example</i>
Track number. This is the usual display.	
Elapsed time for the whole disc.	
Elapsed time for the current track.	
Time remaining for the whole disc.	
Blank.	

Scanning a disc

The scan controls allow you to move quickly to any position on the disc at approximately 20 times normal speed.

During scanning you hear samples of the sound, and the display automatically changes to show the elapsed time for the whole disc unless you have already selected one of the other time displays.

This function is only available from the remote.

To scan through a disc

- Press **▶▶** or **◀◀** (remote).

The display will show your position on the disc; for example:



- Press **▶** (front panel or remote) when you have reached the position you want to play.

Changing the absolute phase

You can use the remote to change the absolute phase of the analogue output signal, which in some circumstances can give noticeable improvement in realism.

To display the phase setting

- Press **Phase** (function **off** on the remote).

The display will show:



Phase +

To change the phase setting

- Press **Phase**.

The display will show the new phase setting; for example:



Phase -

Setting up the compact disc player

This chapter explains how to install the compact disc player. It describes what you should find when you unpack the compact disc player, how you should connect it to your other audio equipment, and the siting constraints.

You should not make any connections to the compact disc player or to any other component in your system whilst the AC power supply is connected and switched on.

Unpacking

The 588 Compact Disc Player comes in a box containing the following components:

- Meridian 588 Compact Disc Player.
- Meridian System Remote.
- Meridian Comms lead.
- Power cord.
- Optical connector blanking plug.
- This manual.

If any of these items are missing please contact your dealer. We suggest that you retain the packing in case you need to transport the unit.

Radio interference

FCC Warning: This equipment generates and can radiate radio frequency energy and if not installed and used correctly in accordance with our instructions may cause interference to radio communications or radio and television reception. It has been type-tested and complies with the limits set out in Subpart J, Part 15 of FCC rules for a Class B computing device. These limits are intended to provide reasonable protection against such interference in home installations.

EEC: This product has been designed to comply with the limits set out in EN55013 and EN55020C.



Positioning the compact disc player

Safety warnings

- Do not expose the unit to dripping or splashing.
- Do not place any object filled with liquid, such as a vase, on the unit.
- Do not place naked flame sources, such as lighted candles, on the unit.

To avoid overheating

Do not position the compact disc player:

- In direct sunlight.
- Near heat sources, such as a radiator.
- Directly on top of heat producing equipment, such as a power amplifier.

Ensure that air can flow through the cooling slots on the base and top cover.

To avoid interference

Do not position the compact disc player:

- Near strong magnetic radiation, such as near a power amplifier.
- Near to a television, or where connecting cables may be subject to or cause interference.

Connecting the compact disc player

Back panel

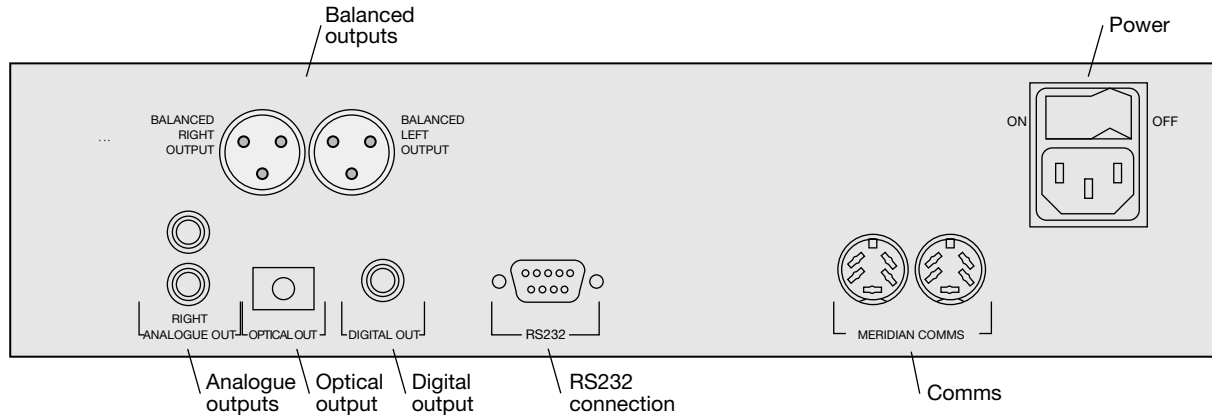

The compact disc player provides two analogue and two digital outputs to allow you to choose the highest-quality method of connection to your system.

The 588 Compact Disc Player produces an extremely low-noise low-jitter electrical digital output, and this is the recommended method of connection to digital equipment.

Audio connections

The table opposite gives details of the alternative audio outputs.

The digital connections should be made with high quality 75Ω screened cable. Suitable cables are available from Meridian. We do not recommend using audio cables which do not have adequate shielding or the correct impedance, or cables intended for UHF applications, as these do not provide adequate shielding in the 1–30MHz region.

The analogue connections should be made using high-quality screened cable, taking care to connect the left and right channels correctly.

<i>Use this output</i>	<i>To connect to this</i>
DIGITAL OUT	Meridian DSP Loudspeakers, a D/A converter, or a digital preamplifier, using digital cable.
OPTICAL OUT	A D/A converter or digital preamplifier, using optical fibre.
ANALOGUE OUT	A 501 Control Unit, or other audio equipment, using conventional analogue audio leads.
BALANCED OUTPUTS	A 502 Analogue Controller, or other equipment with balanced analogue inputs.

Communications connections

The following table gives details of the communications connections:

<i>Use this connection</i>	<i>To connect to this</i>
COMMS	Other Meridian 500 series equipment, or Meridian DSP loudspeakers.
RS232 connection	For future expansion, to allow the 588 to be interfaced to a computer. Contact your dealer for more information.

To connect to other Meridian 500 Series equipment

- Connect one of the COMMS sockets on the back panel of the compact disc player to one of the COMMS sockets on another 500 Series unit, using the 500 comms lead provided.

The sequence in which you connect the units is not important.

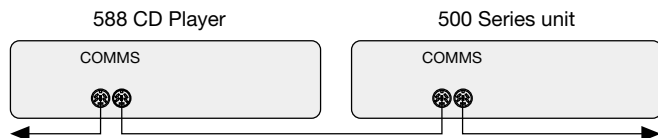

Then configure the units with the following automatic setup procedure:

- Switch all the units to standby.
- Press Clear (remote).

Each unit will display:

Auto

One unit will then be designated as the controller, and display:

Con.

This is the unit that will respond to the remote.

All the other units will be configured as non-controllers, and display:

N. Con.

Your system is now set up and ready for use.

- If for any reason the automatic setup does not give the configuration you want, restore the default operation by selecting the standard type; see *Choosing standard settings*, page 26.

Note: Do not, under any circumstances, connect any equipment other than Meridian 500 or 800 Series to the socket marked COMMS on the back of the compact disc player.

Connecting audio

To connect to a preamplifier with balanced inputs (eg Meridian 502 Analogue Controller)

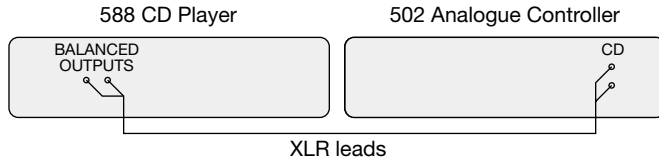

- Connect the BALANCED outputs from the 588 Compact Disc Player to a suitable pair of balanced inputs on the preamplifier, such as the CD inputs, using XLR leads.

To connect to a preamplifier with phono inputs (eg Meridian 501 Control Unit)

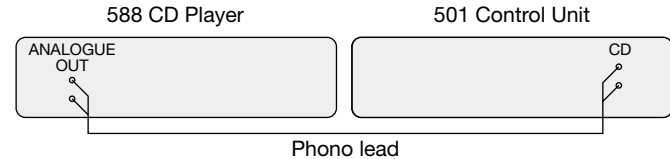

- Connect the ANALOGUE OUT connections from the 588 Compact Disc Player to a suitable pair of audio inputs on the preamplifier, such as the CD inputs, using phono leads.

To connect to Meridian DSP loudspeakers

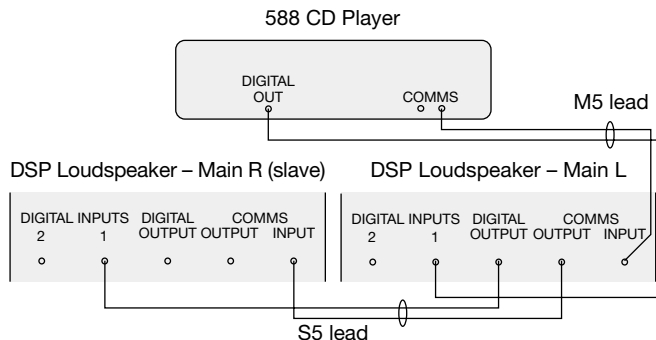

- Connect the DIGITAL OUT from the 588 Compact Disc Player to DIGITAL INPUT 1 on the master DSP loudspeaker, using an M5 lead.
- Connect one of the COMMS sockets on the 588 Compact Disc Player to the COMMS input on the master DSP loudspeaker, using an M5 lead.
- Connect the DIGITAL and COMMS output from the left DSP loudspeaker to the DIGITAL and COMMS INPUTS on the slave DSP loudspeaker, using an S5 lead.

Configuring the compact disc player

Many advanced aspects of the 588 Compact Disc Player can be configured to alter the way it operates with the other Meridian equipment in your system.

These settings are initially set to standard values, which are suitable for most situations, and this chapter describes how to restore the standard settings.

It then gives details of the more advanced settings and explains how to change them.

Choosing standard settings

The compact disc player provides a standard setting, called Type 1, which configures the 588 into the most commonly needed configuration.

Choosing Type 1 overrides any other configuration you may have performed, and so can be used to reset the configuration of the unit.

To restore the standard settings

- Switch the 588 to standby.
- Hold down **Off** (front panel).

After a short delay the display will show:



Type...

Followed by:



Type

- Press **◀▶** on the front panel to confirm that you want to reset the configuration.

The display shows:



Type 1

- Wait until the display shows:



Wait...

The display then shows:



Type 1

- Press **Off** to switch back to standby.
- Switch on again to use the 588 with the standard configuration.

Specifying information about your system

You can configure the operation of the 588 Compact Disc Player to suit the way your system is set up, and the way in which you want to use it.

These settings are configured automatically to appropriate values when you choose the standard type settings, and you should not normally need to alter them; see *Choosing standard settings*, page 26.

To configure the compact disc player

- Switch the 588 to standby.
- Hold down the **Display** key on the front panel.

The display will initially show the software revision number, then:



Config

It will then show the first configuration option:



Auto

- Press **Display** to move between the options.
- Press **◀** or **▶** to change the value of the current option.

The table below shows the options you can configure:

<i>Option</i>	<i>Initial Value</i>
Controller mode (Auto, Con, or NCon).	Auto
System address (1–8).	S.A. 1
Product address (1–8).	P.A. 1
Start source.	S.S. CD
Volume displays (Y or N).	Vol N



Troubleshooting

This chapter provides suggested solutions to typical problems that may occur when setting up or using the compact disc player.

If you are still not able to resolve a difficulty with the help of this guide and the suggestions in the following pages, please contact your Meridian dealer or Meridian Audio Ltd.

Troubleshooting

No lights are displayed when switching on

- Check that your AC power supply is connected correctly.
- Check that the ON OFF switch on the back panel is in the ON position.
- Check that the fuse on the compact disc player back panel and the fuse in the unit's power plug have not blown; see *To change the mains fuse*, page 33.

There is no sound when playing a disc

- Check that your preamplifier is switched on, and the volume is at an appropriate level.
- Check that the compact disc player is connected correctly to the other components of your system; see *Connecting the compact disc player*, page 20.
- Check that the correct source has been selected on your preamplifier.
- Check that the compact disc player is not paused.
- Try playing another disc. If this disc works, check the problem disc for signs of dirt or damage.

There is interference on the radio and/or television when the compact disc player is switched on

Before following the steps below, ensure all units are switched off.

If this equipment does cause or suffer from interference to/from radio or television reception then the following measures should be tried:

- Reorient the receiving aerial (or antenna) or route the antenna cable of the receiver as far as possible from the 588 Compact Disc Player and its cabling.
- Ensure that the receiver uses well-screened antenna cable.
- Relocate the receiver with respect to the compact disc player.
- Connect the receiver and this product to different AC outlets.

The display shows No disc when attempting to play a disc

- Check that the disc is positioned correctly in the drawer, with the label uppermost; see *To insert a disc*, page 9.
- Try playing another disc. If this disc works, check the problem disc for signs of dirt or damage.

The display shows Error when attempting to programme a selection

- Check that the disc includes the track number you are attempting to programme.
- Check that you have not already programmed 31 tracks, the maximum number.

A single key press on the remote causes multiple entries

For example, you press 2 and the display shows Track 22. This is because another Meridian unit on the Comms bus is also sending the command.

- Check that the auto setup procedure worked correctly; see *To connect to other Meridian 500 Series equipment*, page 22.
- Try selecting NCon as the Controller mode; see *Specifying information about your system*, page 27.

Creating MP3 discs

MP3 discs can be created from a computer using appropriate MP3 encoding software and a CD-ROM writer.

Generate the MP3 files with a data rate of at least 128Kbits per second. Group the tracks into folders to create separate albums on the disc. Do not create folders within the folders.

Tracks and albums are played in the order in which they are recorded onto the CD-ROM. Usually this will be in alphabetical order of filename.

Note: Multisession discs are not supported.

Maintenance

Cleaning

When cleaning the compact disc player bear in mind that the front of the compact disc player is plastic, and the display panel and lid are glass.

Disconnect the power cord before cleaning the unit.

Note: Do not use abrasive cleaners on any part of the compact disc player.

To clean the case, display panel, and keypad

- Use a slightly damp cloth.

Ensure that no water is allowed to get inside the case, and do not reconnect the power until you are certain that the compact disc player is completely dry.

To clean the audio connections

The audio sockets on the back of the compact disc player are gold-plated and need no cleaning if gold-plated phono plugs are

used. Otherwise, it is recommended that you unplug and reconnect the plugs at least once a year. A proprietary contact cleaner can be used to some advantage.

The electrical digital output should be treated in a similar way.

To change the mains fuse

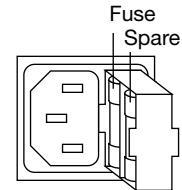

- Remove the mains connector, and pull out the drawer next to the power input to access the fuses.

Before replacing a blown fuse, if possible ascertain the cause of the failure.

The fuse drawer includes a spare fuse. This should be replaced by a fuse of the same rating.

Service and guarantee

Service

The Meridian 500 Series of hi-fi components have been carefully designed to give years of untroubled service. There are no user-serviceable parts inside the case, nor do the units require any form of maintenance.

In the unlikely event that your compact disc player fails to function correctly, it should be returned, in its original packaging, to your Meridian dealer.

In case of difficulty within the UK or USA please contact the appropriate sales and service address shown on page ii.

In case of difficulty outside the UK or USA, contact the importing agent for the territory. A list of Meridian agents abroad is available from Meridian Audio.

No responsibility can be accepted for the compact disc player whilst in transit to the factory or an agent, and customers are therefore advised to insure the unit.

When seeking service under guarantee, proof of the date of purchase will be required.

Guarantee

The 588 Compact Disc Player is guaranteed against defects in material and workmanship for 2 years from the date of purchase.

The guarantee is void if the 588 Compact Disc Player has been subject to misuse, accident, or negligence, or has been tampered with or modified in any way without the written authorisation of Meridian Audio Limited. Note that connecting anything other than the correct network lead to the COMMS sockets may cause damage to the 588 Compact Disc Player which will not be covered by this guarantee. Attempted servicing by unauthorised people may also invalidate this guarantee. Labour and carriage charges are not covered unless by local agreement.

Outside the UK, local warranty liability is restricted to equipment purchased within the territory. Our agents abroad are only under contractual obligation to service under guarantee equipment sold through them. They are entitled to make a non-refundable charge for any service carried out on other equipment.

This guarantee does not limit your statutory rights within the United Kingdom.

Index

- A**
 - absolute phase 16
 - accessories 6
 - analogue outputs 21
 - audio connections 20
 - audio outputs 20
 - analogue 21
 - balanced 21
 - digital 21
 - optical 21
- B**
 - back panel 20
 - balanced outputs 21
- C**
 - cleaning 33
 - comms 21
 - communications connections 21
 - comms 21
 - RS232 21
 - components 18
 - configuration options 27
 - controller mode 27
 - product address 27
 - Start source 27
 - configuration options (*continued*)
 - system address 27
 - volume displays 27
 - configuring 27
 - connections
 - audio 20
 - communications 21
 - continuing play 11
- D**
 - digital output 21
 - disc information 15
 - blank 15
 - changing the display 15
 - disc time remaining 15
 - elapsed disc time 15
 - elapsed track time 15
 - track number 15
- E**
 - error display 31
 - error message 13
- F**
 - front panel 8
 - fuse, changing 33
- G**
 - guarantee 34
- I**
 - inserting a disc 9
- M**
 - maintenance 33
 - Meridian 500 Series 2
 - 502 Analogue Controller 3
 - 557 Stereo Power Amplifier 3
 - 562 Digital Control Unit 3
 - communications 2
 - connecting to 22
 - Meridian DSP loudspeakers,
 - connecting to 24
 - Meridian System Remote 2
 - MP3 discs, creating 32
- N**
 - No disc display 31
- O**
 - optical output 21
- P**
 - pausing play 11
 - continuing after pausing 11
 - phase
 - changing 16

phase (*continued*)

reviewing 16

playing a disc 10

from a particular track 10

repeatedly 12

repeatedly between two

positions 12

preamplifier, connecting to 23

programming a selection 13

clearing 14

R **radio interference** 18

repeating play 12

between two positions 12

cancelling 12

restarting the current track 10

RS232 connection 21

S **safety warnings** 19

scanning a disc 15

selections

adding a track 14

clearing 14

programming 13

selections (*continued*)

removing a track 14

specifying tracks not to play 14

specifying tracks to play 13

service 34

setting up the

compact disc player 17

specification 5

standard settings 26

restoring 26

standby 9

switching on from 9

switching to 9

stopping play 11

T **tracks**

restarting the current track 10

starting play from a particular

track 10

troubleshooting 30

U **unpacking** 18

V **ventilation** 19